

Digital electronics

Lecture - 2

Dr. Tarun Kumar Dey,

Professor in Physics

HOD ,Department of Electronics ,

L.S College; BRA Bihar University, Muzzaffarpur

Online platform :meet.findmementor.com

NOT gate : If any one of input is on out put will be off then this type of gate is called NOT gate .

A logical inverter, sometimes called a *NOT gate* to differentiate it from other types of electronic inverter devices, has only one input. It reverses the logic state. If the input is 1, then the output is 0. If the input is 0, then the output is 1.

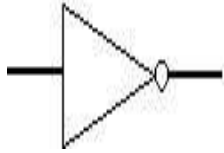

Inverter or NOT gate

Truth table

Input	Output
1	0
0	1

$$A \cdot \bar{A} = 0$$

NOR gate : The *NOR gate* is a combination of NOT and OR gates .
Its output is "true" if both inputs are "false." Otherwise, the output is "false."



NOR gate

Truth table

Input 1	Input 2	Output
0	0	1
0	1	0
1	0	0
1	1	0

NAND gate : The NAND gate is a combination of AND and NOT gates.

It acts in the manner of the logical operation "AND" followed by negation.

The output is "false" if both inputs are "true." Otherwise, the output is "true."

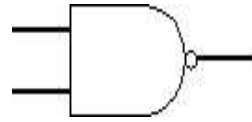

NAND gate

Truth Table

Input 1	Input 2	Output
0	0	1
0	1	1
1	0	1
1	1	0

XOR gate : If inputs are identical then output will be off , if inputs are not identical then output will be on this type of gate is called **XOR gate** .

The **XOR** (exclusive-OR) gate acts in the same way as the logical "either/or." The output is "true" if either, but not both, of the inputs are "true." The output is "false" if both inputs are "false" or if both inputs are "true." Another way of looking at this circuit is to observe that the output is 1 if the inputs are different, but 0 if the inputs are the same.



XOR gate

Truth table

Input 1	Input 2	Output
0	0	0
0	1	1
1	0	1
1	1	0

XNOR gate : The *XNOR (exclusive-NOR) gate* is a combination of XOR gate followed by an inverter. Its output is "true" if the inputs are the same, and "false" if the inputs are different.

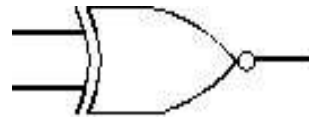

XNOR gate

Truth table

Input 1	Input 2	Output
0	0	0
0	1	1
1	0	1
1	1	0

Using combinations of logic gates, complex operations can be performed. In theory, there is no limit to the number of gates that can be arrayed together in a single device.

But in practice, there is a limit to the number of gates that can be packed into a given physical space.

Arrays of logic gates are found in digital ICs. As IC technology advances, the required physical volume for each individual logic gate decreases and digital devices of the same or smaller size become capable of performing ever-more-complicated operations at ever-increasing speeds.

High or low binary conditions are represented by different [voltage](#) levels.

The logic state of a terminal can, and generally does, change often as the circuit processes data.

In most logic gates, the low state is approximately zero [volts](#) (0 V), while the high state is approximately five volts positive (+5 V).

Logic gates can be made of [resistors](#) and transistors, or diodes. A resistor can commonly be used as a pull-up or pull-down resistor.

Pull-up or pulldown resistors are used when there are any unused logic gate inputs to connect to either a logic level 1 or 0 respectively.

This prevents any false switching of the gate. Pull-up resistors are connected to V_{cc} (+5V), and pull-down resistors are connected to ground (0 V).

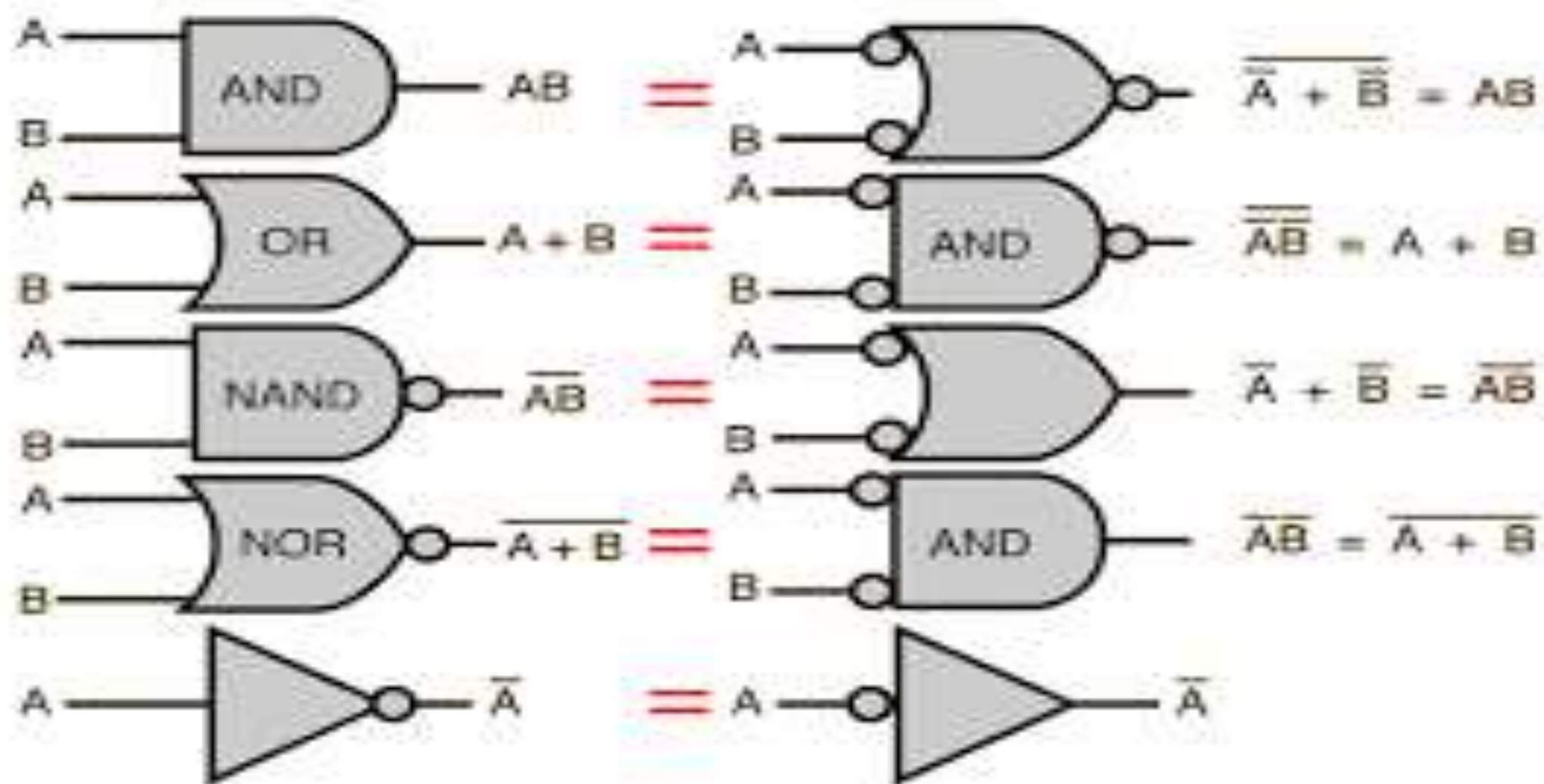

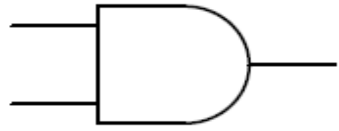

AND

A	B	Output
0	0	0
0	1	0
1	0	0
1	1	1

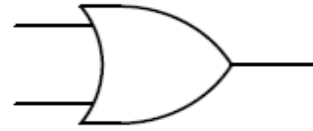

OR

A	B	Output
0	0	0
0	1	1
1	0	1
1	1	1

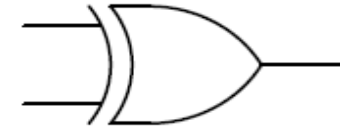

XOR

A	B	Output
0	0	0
0	1	1
1	0	1
1	1	0



NAND

A	B	Output
0	0	1
0	1	1
1	0	1
1	1	0



NOR

A	B	Output
0	0	1
0	1	0
1	0	0
1	1	0

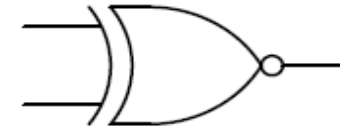

XNOR

A	B	Output
0	0	1
0	1	0
1	0	0
1	1	1